

# Red 4Pre

---

58 in / 64 out Thunderbolt™ 2 audio interface – with Pro Tools | HD and Dante™ network audio connectivity

## User Guide



# CONTENTS

---

About this User Guide .....	4
Box Contents .....	4
<b>Introduction</b> .....	<b>5</b>
Key Features .....	5
System Block Diagram .....	6
Red 4Pre Controls and Connections .....	7
Front Panel .....	7
Rear Panel .....	8
Physical Characteristics .....	9
Power Requirements .....	9
<b>Operation</b> .....	<b>10</b>
<b>INPUTS</b> .....	10
Analogue Inputs .....	10
Input Controls .....	10
Preamp Overview Screen .....	10
Preamp Focus Screen .....	10
Input Configuration .....	11
Input Functions .....	11
Encoder Toggle Function .....	12
Line Inputs 5 – 8 .....	12
<b>DIGITAL INPUTS</b> .....	13
ADAT .....	13
S/PDIF .....	13
Loopback Input .....	13
<b>DANTE CONNECTION</b> .....	13
<b>MONITORING</b> .....	14
Monitors .....	14
Monitor Display .....	14
Mute and Dim .....	14
Headphones .....	14
<b>METER DISPLAY</b> .....	15
Meter Source Selection .....	15
<b>ANALOGUE OUTPUTS</b> .....	15
<b>THUNDERBOLT CONNECTION</b> .....	16
Logic Pro X Setup .....	16

<b>PRO TOOLS CONNECTION</b> .....	<b>17</b>
Using Red 4Pre with other Pro Tools   HD interfaces .....	17
Loop Sync .....	17
Pro Tools Setup .....	18
<b>Global Settings</b> .....	<b>19</b>
Host .....	19
Sync .....	19
Retain .....	19
Routing .....	19
<b>Focusrite Control</b> .....	<b>20</b>
System Requirements .....	20
Software Installation .....	20
Operation .....	20
Device Settings .....	20
Mixing & Routing .....	20
Device Settings GUI .....	21
Monitor Controls .....	21
<b>Appendices</b> .....	<b>22</b>
Appendix 1 – Connector Pinouts .....	22
XLR Connectors .....	22
DB25 (AES59) Connector .....	22
1/4" Jack Connectors .....	23
Pro Tools Interface .....	23
BNC Connectors .....	23
Ethernet Connector .....	23
Appendix 2 – Channel Allocation .....	24
Sample Rate: 44.1 / 48 kHz .....	24
Sample Rate: 88.2 / 96 kHz .....	25
Sample Rate: 176.4 / 192 kHz .....	26
Appendix 3 – AIR information .....	27
<b>Performance and specifications</b> .....	<b>28</b>
Focusrite Red 4Pre Warranty and Service .....	30
Registering Your Product .....	30
Customer Support and Unit Servicing .....	30
Troubleshooting .....	30

## About this User Guide

This user guide applies to the Red 4Pre Thunderbolt Interface. It provides information about installing and operating the unit and how it can be connected into your home or studio system.

## Box Contents

- Red 4Pre unit
- IEC AC mains cable
- Product registration card – which provides the following important information:
  - Unit serial number
  - Bundle code *(for registering your product and for accessing your free software)*

*Thunderbolt™ and the Thunderbolt logo are trademarks of Intel Corporation in the U.S. and/or other countries.*

*Dante™ and Audinate™ are registered trademarks of Audinate Pty Ltd.*

# INTRODUCTION

---

Thank you for purchasing the Focusrite Red 4Pre.



Red 4Pre is a dual Thunderbolt™ & Pro Tools | HD audio interface and preamplifier, suitable for a wide range of audio integration applications.

Featuring Mic, Line and Instrument analogue inputs and fourteen analogue outputs – including independent loudspeaker and headphone monitoring and LCD meter display. Red 4Pre provides an interface for Pro Tools | HD equipped workstations and, with its built-in Dante™ card, is ready for networked audio expansion via the dual Ethernet ports.

## Key Features

- Two Thunderbolt 2 Interface ports for direct or chained connection.
- 8 line-level input and output signals via DB25 connectors on the rear panel.
- Four remote controlled microphone preamps providing up to 63dB of gain, each with phantom power, high-pass filter, phase-reverse and 'AIR' mode. *See Appendix 3, page 27 for further information.*
- Two instrument inputs accessed via front-mounted 1/4" jacks.
- Analogue monitoring via dedicated balanced 1/4" jack outputs on the rear panel, plus two independent headphone outputs on the front panel.
- Digital devices can be accommodated via the dual ADAT I/O and S/PDIF connections.
- Two Primary Mini DigiLink connectors provide up to 60 input and 64 output channels of I/O to Pro Tools | HD.
- Dual Ethernet ports provide up to 32 x 32 channels of networked audio expansion over Dante.
- BNC connectors allow the Red 4Pre to sync or slave to external devices via Word Clock.
- Permanent 8-channel LCD meter display – selectable to show all input types.
- Simple host and sync selection setup.
- Focusrite Control application allows full remote hardware operation, plus mixing and routing control when in Thunderbolt host mode.

# System Block Diagram

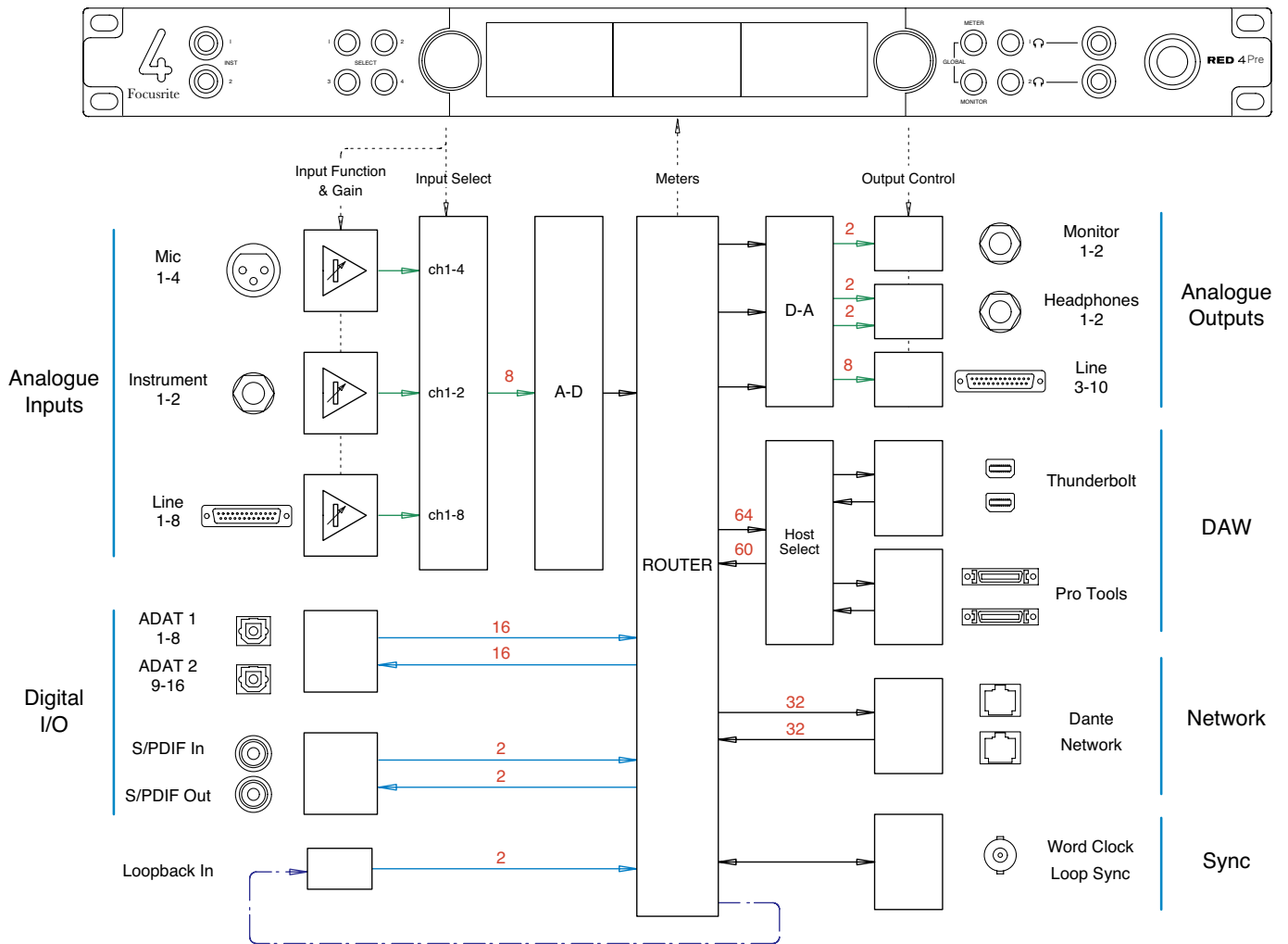

Numbers indicating channel capacities relate to a 44.1/48 kHz sample rate. Refer to the Channel I/O tables on pages 24–26 for the channel counts at higher sample rates.

## Red 4Pre Controls and Connections

### Front Panel

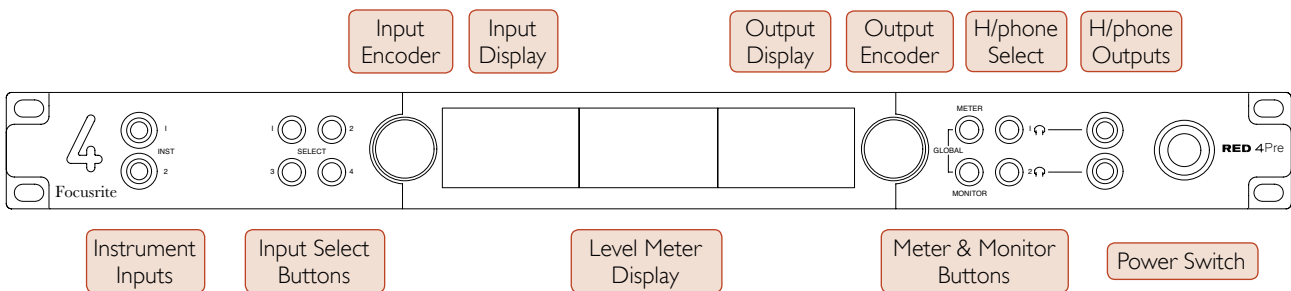

- **Instrument Inputs.** Two high-impedance inputs on 1/4" jack sockets.
- **Input Select** buttons provide direct access to the menu settings for analogue input channels 1–4.
- The **Input Encoder** and its associated **Display** is used to select and adjust the configuration menu settings for the input channels; it also functions as the input gain control.
- The **Level Meter** is an eight channel, switchable LCD meter which is able to display groups of input signals.
- The **Output Encoder** functions as the volume control for the monitor and headphone outputs. It is used to configure the global system settings, control the meter selection and select the monitor dim and mute features. Its function is determined by the adjacent Monitor, Meter and Headphone Select buttons.
- The **Meter** button calls up the selection menu for the level meters onto the Output Encoder **display**.
- The **Monitor** button assigns the output Encoder to the monitor loudspeaker functions.

*Pressing the **Meter** and **Monitor** buttons simultaneously enters Red 4Pre's **Global** configuration menu, where host, sync, power-up and network settings are assigned.*

- The **Headphone 1** and **2** buttons assign the Output Encoder to the selected headphone control functions.
- **Headphone Outputs** are standard 1/4" stereo jacks.

## Rear Panel

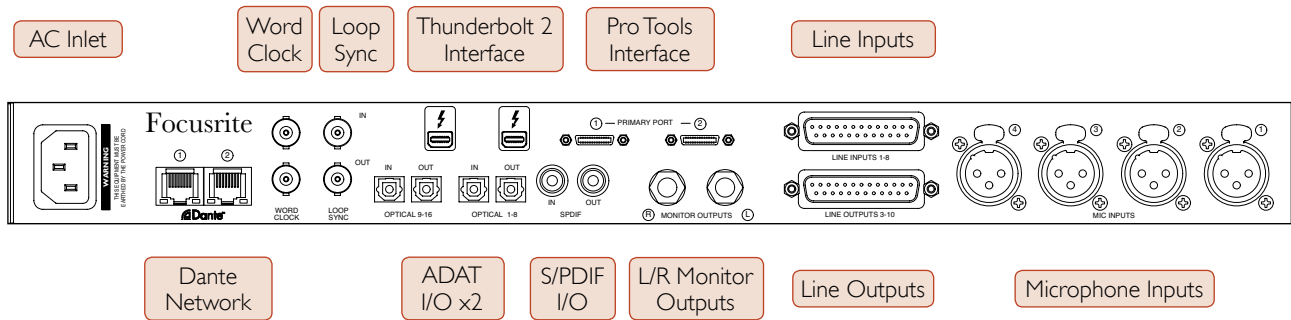

- **AC Mains Inlet.** Standard IEC receptacle for connection of AC mains. Red 4Pre features a 'Universal' PSU, enabling it to operate on any supply voltage between 100 V and 240 V AC.
- **Word Clock – Input** allows synchronisation to word clock.
- **Word Clock – Output** provides an output of the chosen system clock reference.
- **Loop Sync I/O** sockets allow Red 4Pre to integrate with a standard Pro Tools system I/O chain.
- Dual **Thunderbolt 2** Connection. Two ports allow either direct or chained connection to your workstation.
- **Pro Tools Interface.** Two Mini DigiLink Primary connectors; use Mini DigiLink cables to connect to the Pro Tools | HD and HDX PCIe card.
- **Line Inputs** on 25-way D-Sub female connector. The line inputs are wired according to the AES59 Standard (also known as the TASCAM Analogue standard).  
*Note that Line input circuits 1 – 4 can be re-assigned to the Microphone and/or Instrument connectors so may not always be available in the D-sub. See page 11 for further information.*
- **Line Outputs** on 25-way D-Sub female connector.
- **Microphone Inputs** on latching XLR3-F connectors.
- **Network.** Two RJ45 Ethernet connectors for the Dante network. The connectors form an integral 2-port switch, allowing either to be used on the network
- **ADAT I/O 1 and 2.** Two independent 8-channel ADAT optical inputs and outputs using standard TOSLINK connectors.
- **S/PDIF I/O.** 2-channel digital interface on RCA (phono) connectors.
- **Monitor Outputs.** Balanced 1/4" TRS jacks for connection of Left and Right monitor loudspeakers. Outputs are at line level so unpowered speakers will require external amplification.

See Appendix 1, page 22 for the connector pinouts.



## Physical Characteristics

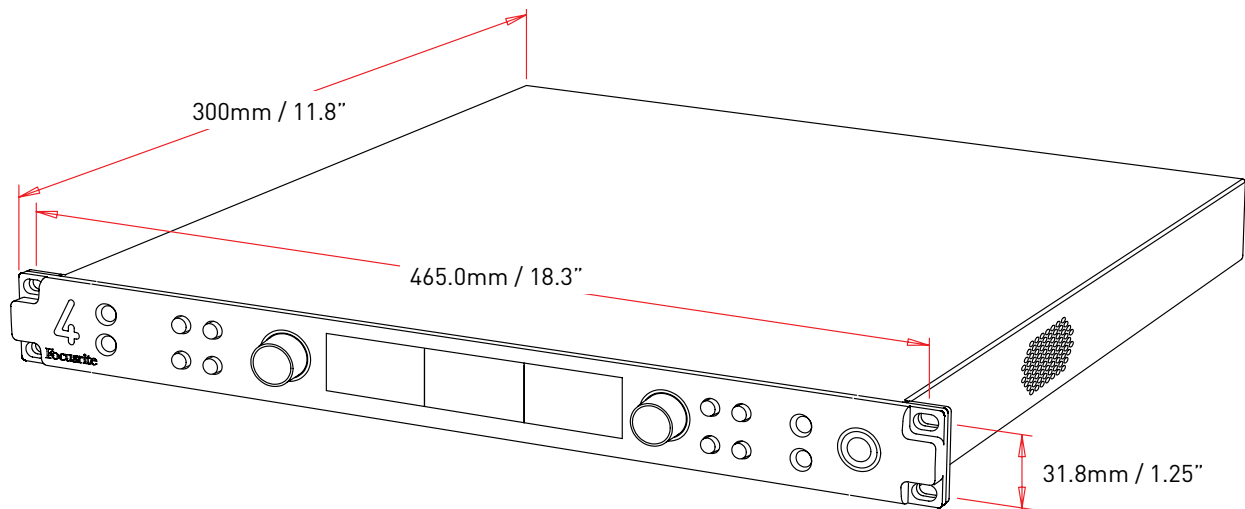

Red 4Pre dimensions are illustrated in the diagram above.

Red 4Pre requires 1U of vertical rack space and at least 360 mm of rack depth, to allow for cables. Red 4Pre weighs 4.97 kg and for installations in a fixed environment (eg., a studio), the front-panel rack mountings will provide adequate support. However, if the units are to be used in a mobile situation (eg., flight-cased for touring, etc.), it is recommended that side support rails or shelves are used within the rack.

Cooling is by fan assistance from side to side; the fan used is low-speed and low-noise. Do not mount the unit immediately above any other equipment which generates significant heat, for example, a power amplifier. Also, ensure that when mounted in a rack, the side vents are not obstructed.

*Note. The maximum operating environmental temperature is 40°C / 104°F.*

## Power Requirements

Red 4Pre is mains-powered. It incorporates a 'Universal' power supply which can operate on any AC mains voltage from 100 V to 240 V. The AC connection is via a standard 3-pin IEC connector on the rear panel.

A mating IEC cable is supplied with the unit – this should be terminated with a mains plug of the correct type for your country.

The AC power consumption of the Red 4Pre is 35W.

Please note that there are no fuses in Red 4Pre, or other user-replaceable components of any type. Please refer all servicing issues to the Customer Support Team (see "Customer Support and Unit Servicing" on page 30).

# OPERATION

## Inputs

Red 4Pre has the capacity to accommodate eight analogue inputs, two independent 8-channel ADAT inputs, a 2-channel S/PDIF input plus 32 Dante input channels. (Additionally, when in Thunderbolt host mode, an internal 2-channel loopback signal can be added as an extra stereo input – see page 13 for details)

## Analogue Inputs

The 8 analogue inputs can be assigned to the Instrument, Microphone or Line input connectors as follows: Input channels **1** and **2** are selectable as **instrument**, **microphone** or **line** level; Inputs **3** and **4** are **mic** or **line** selectable; Inputs **5 – 8** are **line** level only.

## Input Controls

Input selection and configuration for channels 1 to 4 is carried out using the Preamp **Select** buttons and the **Input Encoder**.

The illuminated Select button identifies the channel being controlled.

- Pressing a Select button makes that channel the active channel  
*Power-up always selects channel 1*
- The Input Encoder acts as the gain control for the active channel
- Pushing ('clicking') the Input Encoder selects menu options or operates the Toggle function (see page 12)



Select Buttons / Input Encoder

## Preamp Overview Screen

This is the default display for input channels 1 to 4. It shows at-a-glance the current input type, gain setting and phantom power status of the four inputs.

The highlighted number indicates the active channel (as shown for channel 1).

Note: a clipping channel will be indicated by its gain level bar changing to red (as shown for channel 3) – reset by pressing the channel's Select button.

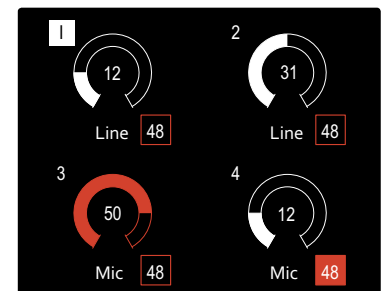

Preamp Overview Screen

## Preamp Focus Screen

Pressing an input Select button brings up the Focus screen which displays additional detail about that channel's current settings.

If no changes are made within approximately 3 seconds, the display will revert to the Overview screen.

In the example shown, channel 1 has the phase and HPF functions enabled.

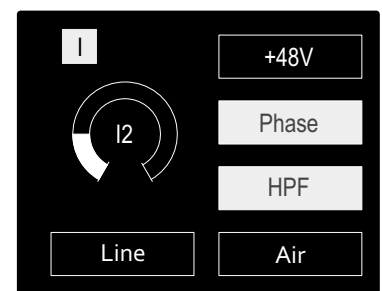

Preamp Focus Screen

## Input Configuration

The settings for an input channel – its input type and function options – are selected via the Config Menu.

- To enter the Config Menu, press-and-hold a channel's Select button

To exit this screen, press any of the channel Select buttons (or, rotate the Input Encoder to the 'Back' option and then click).

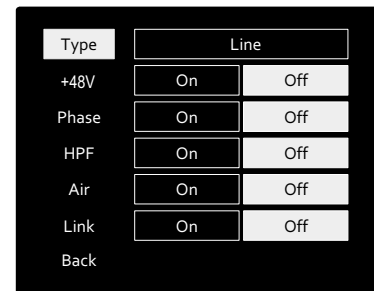

Channel Config Menu Screen

## Input Functions

The following channel functions can be set, or toggled On/Off, from the Config Menu screen:

- **Type** selects the signal input type to be used for the channel:  
For channels 1 & 2: Instrument > Mic > Line  
For channels 3 & 4: Mic > Line
- **+48V** enables phantom power for the selected microphone input
- **Phase** applies phase inversion to the selected channel
- **HPF** switches in the 80Hz high-pass filter
- **AIR** changes the microphone, line and instrument input characteristics to AIR mode. (See Appendix 3, page 27 for further information)
- **Link** combines channels 1 & 2 [and/or 3 & 4] so they operate as a stereo pair. When linked, Gain and Input Type changes to either of the paired channels will be applied to both

*When linking channels, the existing gain and input type settings for channel 1 [or 3] will be applied to channel 2 [or 4]*

- **Back** exits the Config Menu screen and returns to the Overview display

*Pressing any of the channel Select buttons will also exit the Config menu screen)*

To change an input function:

- 1 Rotate the Input Encoder until the required function is highlighted
- 2 Push the Input Encoder to step through the input types or to toggle On/Off

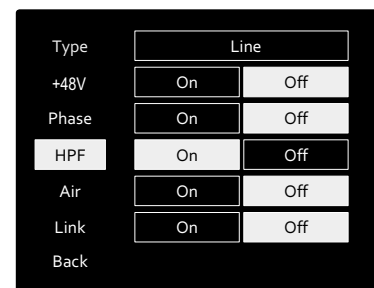

Channel Function Selection

## Encoder Toggle Function

The Input Encoder can be programmed to toggle any one of the input functions with a single push (ie., without having to enter the Config Menu screen). *This can be very useful when, for example, experimenting with microphone phasing.*

To select a function for the Input Encoder toggle feature:

- 1 Enter the Config Menu screen
- 2 Scroll to the function required for the toggle feature
- 3 Press-and-hold the Input Encoder until the confirmation message appears in the input display

The selected function will now toggle on/off\* each time the Input Encoder is clicked.

*\*If 'Type' was selected, clicking the Input Encoder will step through the available inputs.*

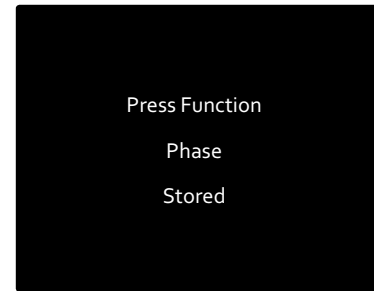
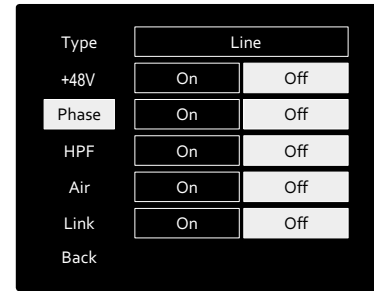

Input Encoder Toggle Confirmation

## Line Inputs 5 – 8

Line input channels 5 to 8 are always available on the input DB25 connector.

The gain of these channels is not variable.

An input signal level of +18 dBu corresponds to 0 dBFS.

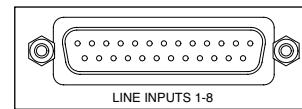

## Digital Inputs

### ADAT

ADAT inputs 1 and 2 are accessed via the rear panel connectors. Signals will be available if the source is connected and locked.

Each In/Out connection provides:

- 8ch at 44.1 / 48 kHz
- 4ch at 88.2 / 96 kHz (SMUX)
- 2ch at 176.4 / 192 kHz (SMUXII)

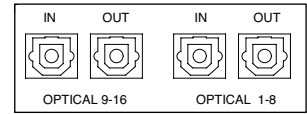

### S/PDIF

A two-channel S/PDIF I/O connection is accessed via the RCA/Phono connectors on the rear panel.

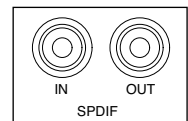

### Loopback Input

The Red 4Pre's virtual loopback inputs allow you to record any mix within Focusrite Control back into your DAW. This could be the audio output of another software application, or an entire monitor mix within Focusrite Control including analogue or digital inputs mixed with any playback signals you wish to capture in your DAW.

Loopback uses the Red 4Pre's virtual inputs, which have no physical connectors on the hardware interface itself, but may be selected in the DAW as signal sources for recording in the same way as any other.

*For Focusrite Control information, see page 20.*



Focusrite Control – Loopback Signal Routing

## Dante Connection

Two switched RJ45 connectors for the Dante network are located on the rear panel. Use a standard Cat 5e or Cat 6 network cable to connect to the Dante audio network.

Incorporated into each socket are LEDs which illuminate to indicate a valid network connection and network activity.

*Note that the Dante connectors are configured for a single, switched network – they cannot be used as primary and secondary ports on a redundant network.*

For more information on Dante networks, see Audinate's website: <http://www.audinate.com/>

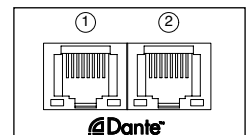

# Monitoring

## Monitors

Monitor outputs, at line level, are provided via the 1/4" jack outputs on the rear panel.

- The Output Encoder will adjust the monitor output level whenever the **Monitor** button is illuminated

### Monitor Display

The monitor display shows the current volume level and whether either Dim or Mute is active. 'Dim' attenuates the signal by 18dB.

The L/R meter display shows a pre-fade level (the signal level present before the Output Encoder).

The display also shows the Global Host and Sync settings and their lock status flags (see 'Global Settings' on page 19).

### Mute and Dim

Mute and Dim functions are individually enabled via the Monitor Setup menu. Additionally, the Output Encoder can be programmed to toggle either the Dim or Mute function when clicked.

Menu activation:

- 1 Press-and-hold the **Monitor** button to enter the Setup menu
- 2 Rotate the Output Encoder to highlight either Dim or Mute
- 3 Click to select On or Off
- 4 To exit, press Monitor again (or select the 'Back' option)

Toggle Function programming:

- 1 Enter the Monitor Setup menu as above
- 2 Rotate to highlight the function to be programmed
- 3 Press-and-hold the Output Encoder until the confirmation message appears

The selected function will now toggle on/off each time the Output Encoder is clicked.

## Headphones

Two independent stereo headphone outputs are available on the front panel.

- To adjust a headphone's volume level – or to activate Dim or Mute – press one of the **Headphone Select** buttons  
*Also see: Focusrite Control – Monitor Controls, on page 21*

For Dim and Mute activation and programming, refer to the 'Mute and Dim' section above but substitute 'Monitor button' with the appropriate Headphone Select button.

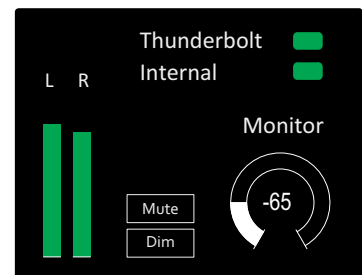

Monitor Display

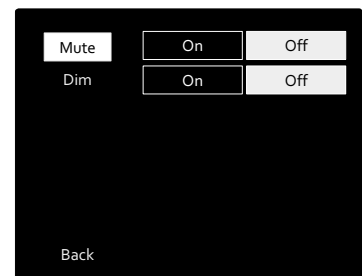

Monitor Setup Menu

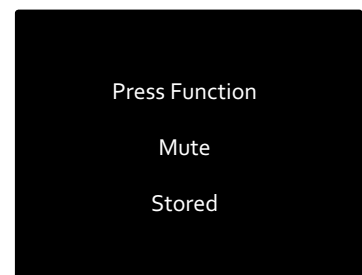

Encoder Toggle Confirmation



Headphone Select Buttons

## Meter Display

The centre LCD screen displays eight level meters. These indicate the internal signal level, after A-D conversion, with 0 dBFS being at full scale.

A red clip indicator is displayed on channels that reach clipping point.

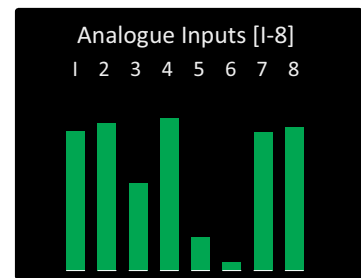

### *Meter Source Selection*

To select the source for the 8-channel LCD display:

- 1 Press the **Meter** button on the front panel to access the Meter Source-List
- 2 Use the Output Encoder to scroll to the required input
- 3 Click the Output Encoder to make the selection
- 4 Press Monitor or one of the Headphone Select buttons to exit

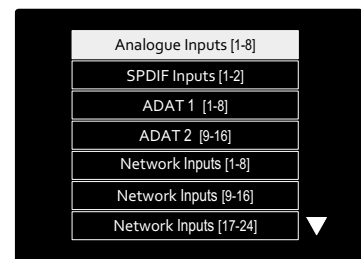
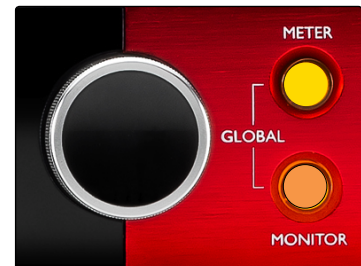

Meter Source List

## Analogue Outputs

8 analogue outputs are provided on the 25-way D-type female connector on the rear panel.

Analogue outputs are at fixed gain. 0 dBFS corresponds to a signal level of +18 dBu.

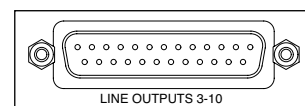

## Thunderbolt Connection

Confirm that Red 4Pre's Host setting is set to 'Thunderbolt', see *Global Host Settings* on page 19.

Two Thunderbolt 2 connectors are located on the rear panel.

Connect to the host or into the chain using standard Thunderbolt cables (not supplied).

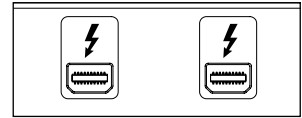

See *appendix 2* on pages 24–26 for the channel I/O allocation tables.

## Logic Pro X Setup

- From the menu bar, go to: **Logic Pro X > Preferences > Audio...**
- Under the **Devices** tab, set: **Input Devices** and **Output Devices** to 'Focusrite Thunderbolt'



The following steps are optional but will simplify signal routing:

- From the menu bar, go to: **Mix > I/O Labels...**
- Select the I/O labels to be provided by the driver

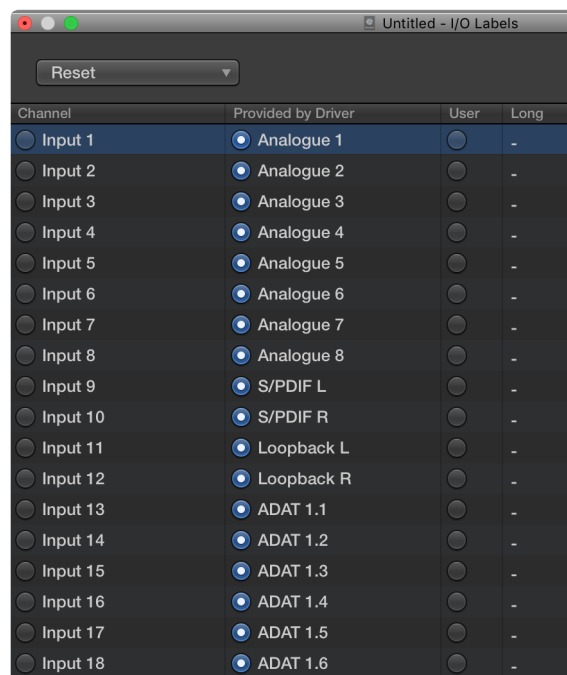



## Pro Tools Connection

Confirm that Red 4Pre's Host setting is set to 'Pro Tools', see *Global Host Settings* on page 19.

Connect both rear panel PRIMARY ports to a Pro Tools | HDX card using Mini DigiLink cables.

Each Pro Tools | HDX PCI/PCIe card provides two Mini DigiLink ports (giving the card a capacity of 64 inputs and 64 outputs), thus one Red 4Pre may be connected to each card.

A Red 4Pre will appear as four devices in Pro Tools:

- A: 1-16
- B: 1-16 (Port 1)
- C: 1-16
- D: 1-16 (Port 2)

A maximum of 3 Red 4Pre units can be connected, giving a total I/O capability of 174 inputs and 192 outputs.

*Note that both Red 4Pre ports are Primary connectors; this means that an additional Pro Tools interface cannot be added in series – Red 4Pre does not operate in Expansion mode*

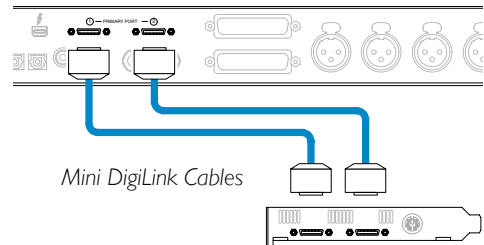

## Using Red 4Pre with other Pro Tools | HD interfaces

Pro Tools | HD I/O audio interfaces may be used on the same Pro Tools system as Red 4Pre. Pro Tools interface units can be added by using additional Pro Tools | HDX PCIe interface cards.

*Connection to a Pro Tools | HD system would require the use of DigiLink to- Mini DigiLink adapter cables.*

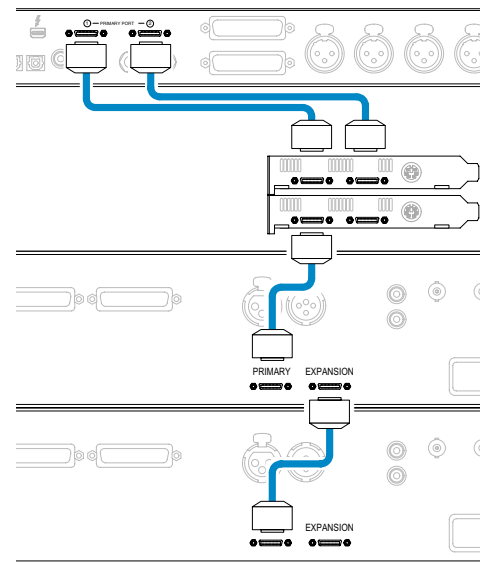

## Loop Sync

It is important when using additional I/O units that the Loop Sync connection is complete between all units:

- Using 75Ω BNC cables, connect each LOOP SYNC OUT connector to the LOOP SYNC IN connector on the next I/O unit
- Complete the chain by connecting LOOP SYNC OUT on the final I/O unit back to LOOP SYNC IN on the first unit

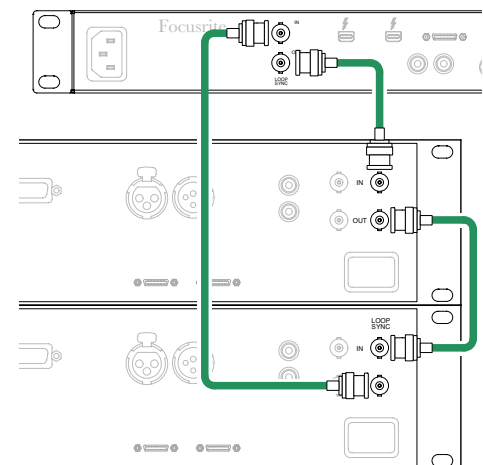

## Pro Tools Setup

- From the Pro tools menu bar, go to: **Setup > Playback Engine...**
- In the **Playback Engine** menu pop-up, select: 'HD Native'

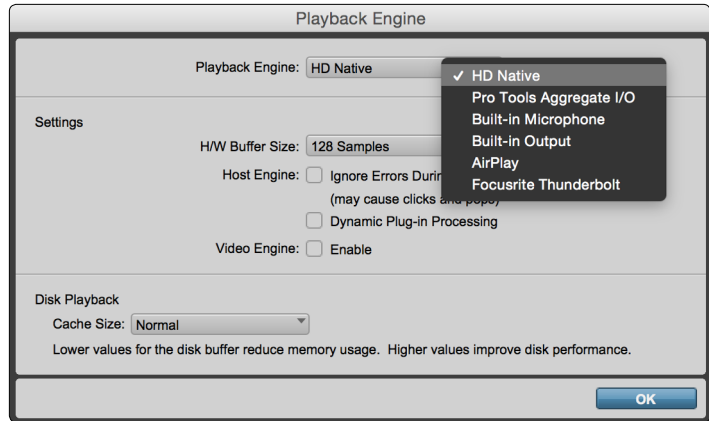

The following steps are optional but will simplify signal routing:

- From the menu bar, go to: **Setup > I/O Setup...**
- Ensure your input and output routing tables are routed as follows by selecting the **Default** tab at the bottom left of the page.

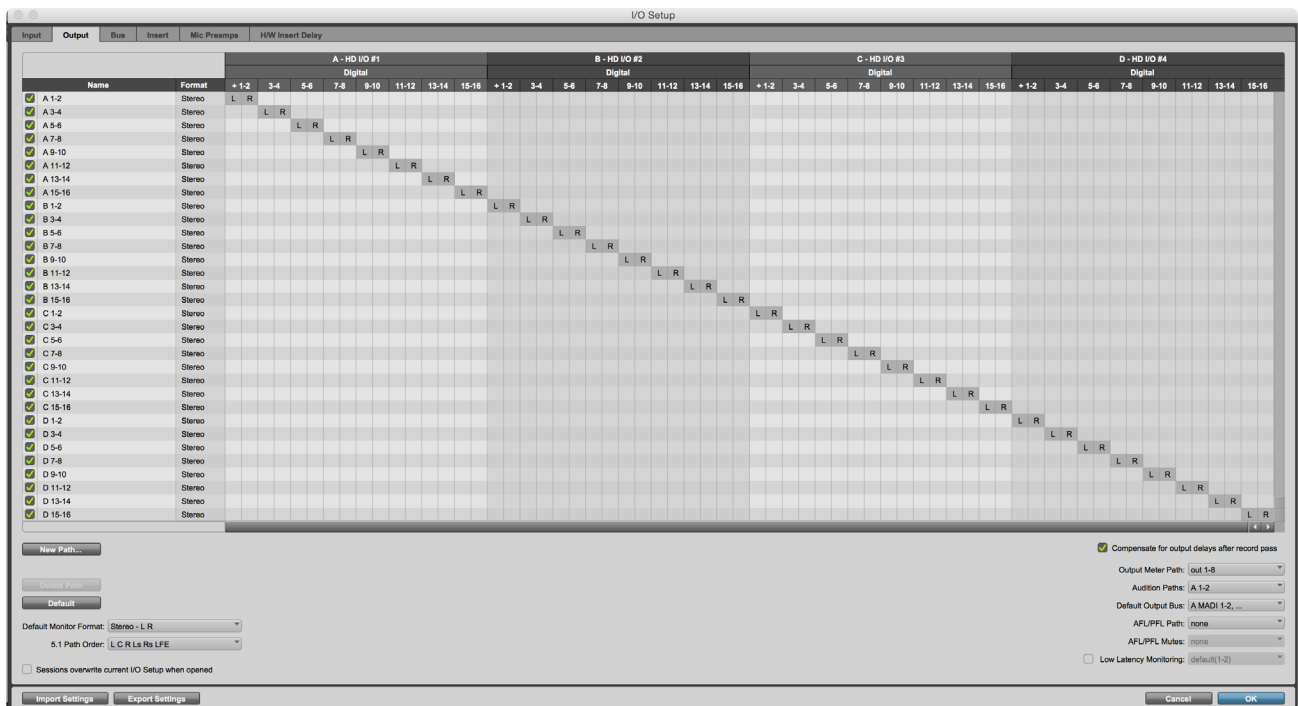

## Notes

1. The number of input and output channels available is dependent on the sample frequency (see channel allocation tables in Appendix 2, pages 24–26)
2. The Loopback input is not available on the Pro Tools host mode
3. Output routing using Focusrite Control is not available in the Pro Tools Host mode

# GLOBAL SETTINGS

Press the **Meter** and **Monitor** buttons simultaneously to enter the global settings menu.

- Rotate the Output Encoder to select a menu item
- Click the Output Encoder to step through the available options

To exit the Global settings screen press the Monitor button (or select the 'Back' option).

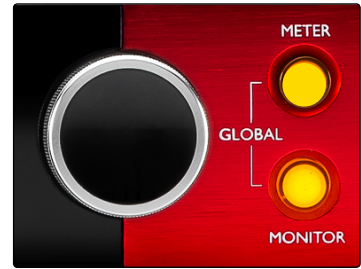

## Host

Selects the connection used for the DAW host:

- Thunderbolt
- Pro Tools

The Lock status in the Monitor display will show green when locked to the DAW host.

*Note: changing Host type will cause the device to perform a power reset.*

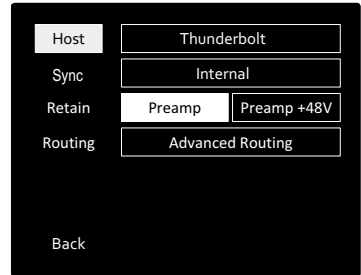

Global Settings Menu

## Sync

Selects the Red 4Pre's sync source:

- Internal – internally generated. *This is the default selection*
- Word Clock – received via the BNC Word Clock In connector
- ADAT 1 – received via the rear Optical In 1-8 connector
- ADAT 2 – received via the rear Optical In 9-16 connector
- S/PDIF – received via the rear S/PDIF In RCA/Phono connector
- Dante – provided by the Dante network connection
- Loop Sync – only applicable when in Pro Tools host mode

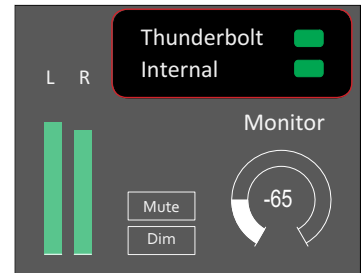

Host and Sync Settings and Lock Status

When sync is established, the Lock status will change to green. A red status indicates no sync.

## Retain

Choose whether the previous phantom power settings are restored on power-up:

- Preamp – all previous settings are returned except the 48V settings, which will be set to Off
- Preamp +48V – all previous settings are returned

## Routing

- Advanced Routing – allows remote routing using the Dante Controller application
- Auto Routing – not currently implemented

# FOCUSRITE CONTROL

---



The Focusrite Control application provides remote control of all Red 4Pre's front panel hardware functions and system settings via a graphical interface on your DAW. Additionally – when operating in Thunderbolt host mode – the application provides control of all input and output routing and mixing functions.

*Please note: This manual includes information relating to Red 4Pre's specific front panel controls and device settings. For compactness, however, the Mixing and Routing operations are not included here but are fully described in the separate 'Focusrite Control User Manual'; this manual can be downloaded at the following link:*

<https://focusrite.com/downloads?product=Red+4Pre>

## System Requirements

Please visit the following link for up-to-date information on computer and operating system compatibility for Focusrite Control: [Compatibility](#)

## Software Installation

The Focusrite Control application for Red 4Pre can be installed as follows:

- Using your browser, go to [www.focusrite.com/register](http://www.focusrite.com/register).
- Follow the on-screen instructions, entering the “Bundle Code” into the form where prompted. *Your Bundle Code can be found on the back of the Getting Started Guide packed with Red 4Pre.*
- Enter the unit's serial number, which can also be found on the back of the Getting Started Guide.
- You will then be able to access the “My Products” page, where Focusrite Control is available for download, complete with activation codes where applicable.
- Download and install Focusrite Control, which contains the necessary drivers for your interface. Follow all on-screen instructions.
- When the installation is complete, you will be prompted to restart your computer.
- After a restart, connect Red 4Pre to your computer with a Thunderbolt cable.

## Operation

The software control screen is divided in to two sections:

### *Device Settings*

Refer to the GUI descriptions on the following page.

### *Mixing & Routing*

Please refer to the separate Focusrite Control User Manual – see link above.

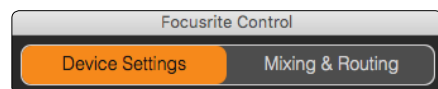

## Device Settings GUI

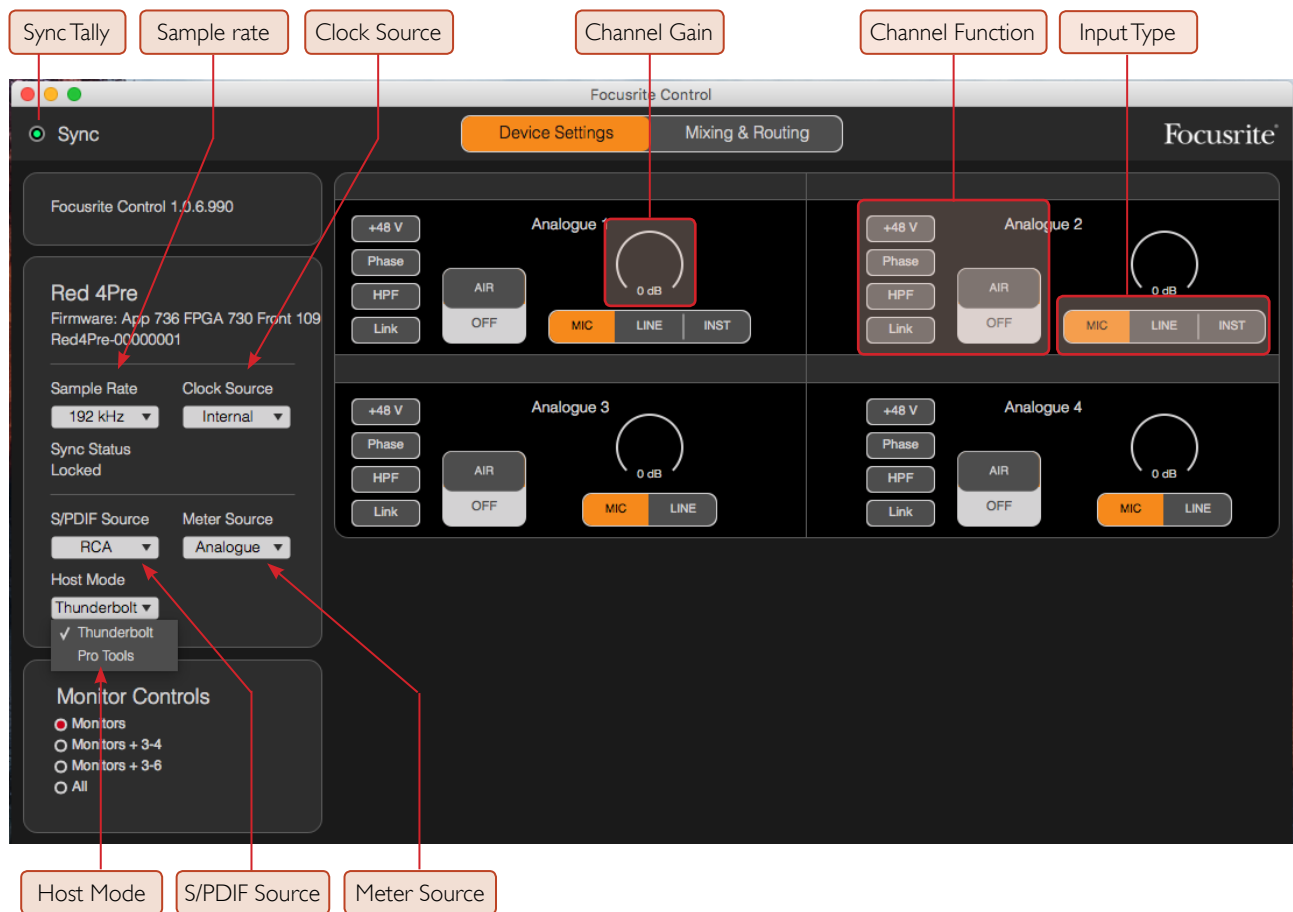

**Sync Tally** – will be illuminated if Red 4Pre is locked to a valid clock source

**Channel Gain** – sets the input gain on analogue channels 1 – 4. Click-and-drag to change

**Channel Function** – click to select an input function. See page 11 for Function descriptions

**Input Type** – click to select the input signal type. Also see page 11 for Type descriptions

**Sample Rate** – select from: 44.1kHz, 48kHz, 88.2kHz, 96kHz, 176.4kHz, 192kHz

**Clock Source** – Internal, S/PDIF, ADAT 1 & 2, Word Clock, Dante, Loop Sync (*Pro Tools host mode*)

**S/PDIF Source** – RCA, Optical

**Meter Source** – Internal, S/PDIF, ADAT 1 & 2, Word Clock, Dante, Loop Sync

**Host Mode** – Thunderbolt or Pro Tools. Changing Host type will cause the device to perform a power reset

### Monitor Controls

Click to select which output channels are being controlled by the unit's Output Encoder:

- Monitors: Monitor L/R Outputs
- Monitors + 3-4: Monitor L/R Outputs + Line Outputs 3-4
- Monitors + 3-6: Monitor L/R Outputs + Line Outputs 3-6
- All: Monitor L/R Outputs + Line Outputs 3-10

# APPENDICES

---

## Appendix 1 – Connector Pinouts

### *XLR Connectors*

Connector type: XLR-3 Female  
 Applies to: Mic Inputs

Pin	Signal
1	Screen
2	Hot (+ve)
3	Cold [-ve]

### *DB25 (AES59) Connector*

Connector type: DB25 Female  
 Applies to: Analogue Line Input / Line Output

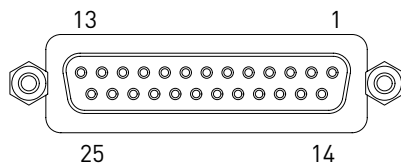

Pin	Signal	
1	Channel 8	+
14	Channel 8	-
2	Ground	
15	Channel 7	+
3	Channel 7	-
16	Ground	
4	Channel 6	+
17	Channel 6	-
5	Ground	
18	Channel 5	+
6	Channel 5	
19	Ground	
7	Channel 4	+
20	Channel 4	-
8	Ground	
21	Channel 3	+
9	Channel 3	-
22	Ground	
10	Channel 2	+
23	Channel 2	-
11	Ground	
24	Channel 1	+
12	Channel 1	-
25	Ground	
13	n/c	

**Appendix 1 – Connector Pinouts** *Continued...*

**1/4" Jack Connectors**

Connector type: Balanced socket  
 Applies to: Monitor Outputs

Connector type: Unbalanced socket  
 Applies to: Instrument Inputs

Pin	Signal
Tip	Hot (+ve)
Ring	Cold (-ve)
Sleeve	Screen

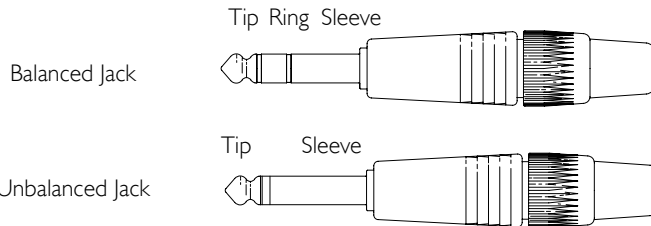

**Pro Tools Interface**

Connector type: Mini DigiLink receptacle  
 Applies to: PRIMARY 1 & 2

**BNC Connectors**

Connector type: 75Ω BNC Socket  
 Applies to: WORD CLOCK IN/OUT  
 LOOP SYNC IN/OUT

**Ethernet Connector**

Connector type: RJ-45 receptacle  
 Applies to: Ethernet (Dante)

Pin	Cat 6 Core
1	White + Orange
2	Orange
3	White + Green
4	Blue
5	White + Blue
6	Green
7	White + Brown
8	Brown



## Appendix 2 – Channel Allocation

Sample Rate: 44.1 / 48 kHz

### Notes

The 'Loopback' inputs are not available in Pro Tools | HD host mode.

Output channel allocations are only fixed when operating on Pro Tools | HD host mode.

Inputs		
1	Mic/Line/Inst	1
2		2
3	Mic/Line	3
4		4
5	Line In	5
6		6
7		7
8		8
9	S/PDIF	L
10		R
11	Loopback	L
12		R
13	ADAT 1	1
14		2
15		3
16		4
17		5
18		6
19		7
20		8
21	ADAT 2	9
22		10
23		11
24		12
25		13
26		14
27		15
28		16
29	Dante	1
30		2
31		3
32		4
33		5
34		6
35		7
36		8
37		9
38		10
39		11
40		12
41		13
42		14
43		15
44		16
45		17
46		18
47		19
48		20
49		21
50		22
51		23
52		24
53		25
54		26
55		27
56		28
57		29
58		30
59		31
60		32
	Not available	

Outputs		
1	Monitor	L
2		R
3	Headphone 1	L
4		R
5	Headphone 2	L
6		R
7	Line Out	3
8		4
9		5
10		6
11		7
12		8
13		9
14		10
15	S/PDIF	L
16		R
17	ADAT 1	1
18		2
19		3
20		4
21		5
22		6
23		7
24		8
25	ADAT 2	9
26		10
27		11
28		12
29		13
30		14
31		15
32		16
33	Dante	1
34		2
35		3
36		4
37		5
38		6
39		7
40		8
41		9
42		10
43		11
44		12
45		13
46		14
47		15
48		16
49		17
50		18
51		19
52		20
53		21
54		22
55		23
56		24
57		25
58		26
59		27
60		28
61		29
62		30
63		31
64		32



## Appendix 2 – Channel Allocation

Continued...

**Sample Rate: 88.2 / 96 kHz**

### Notes

The 'Loopback' inputs are not available in Pro Tools | HD host mode.

Output channel allocations are only fixed when operating on Pro Tools | HD host mode.

Inputs		
1	Mic/Line/Inst	1
2		2
3	Mic/Line	3
4		4
5	Line In	5
6		6
7		7
8		8
9	S/PDIF	L
10		R
11	Loopback	L
12		R
13	ADAT 1	1
14		2
15		3
16		4
17	ADAT 2	9
18		10
19		11
20		12
21	Dante	1
22		2
23		3
24		4
25		5
26		6
27		7
28		8
29		9
30		10
31		11
32		12
33		13
34		14
35		15
36		16
37		17
38		18
39		19
40		20
41		21
42		22
43		23
44		24
45		25
46		26
47		27
48		28
49		29
50		30
51		31
52		32
	Not available	

Outputs			
1	Monitor	L	
2		R	
3	Headphone 1	L	
4		R	
5	Headphone 2	L	
6		R	
7	Line Out	3	
8		4	
9		5	
10		6	
11		7	
12		8	
13		9	
14		10	
15		S/PDIF	L
16			R
17	ADAT 1	1	
18		2	
19		3	
20		4	
21	ADAT 2	9	
22		10	
23		11	
24		12	
25	Dante	1	
26		2	
27		3	
28		4	
29		5	
30		6	
31		7	
32		8	
33		9	
34		10	
35		11	
36		12	
37		13	
38		14	
39		15	
40		16	
41		17	
42		18	
43		19	
44		20	
45		21	
46		22	
47		23	
48		24	
49		25	
50		26	
51		27	
52		28	
53		29	
54		30	
55		31	
56		32	
	Not available		

## Appendix 2 – Channel Allocation

Continued...

**Sample Rate: 176.4 / 192 kHz**

### Notes

The 'Loopback' inputs are not available in Pro Tools | HD host mode.

Output channel allocations are only fixed when operating on Pro Tools | HD host mode.

Inputs		
1	Mic/Line/Inst	1
2		2
3	Mic/Line	3
4		4
5	Line In	5
6		6
7		7
8		8
9	S/PDIF	L
10		R
11	Loopback	L
12		R
13	ADAT 1	1
14		2
15	ADAT 2	9
16		10
17	Dante	1
18		2
19		3
20		4
21		5
22		6
23		7
24		8
25		9
26		10
27		11
28		12
29		13
30		14
31		15
32		16
	Not available	

Outputs		
1	Monitor	L
2		R
3	Headphone 1	L
4		R
5	Headphone 2	L
6		R
7	Line Out	3
8		4
9		5
10		6
11		7
12		8
13		9
14		10
15	S/PDIF	L
16		R
17	ADAT 1	1
18		2
19	ADAT 2	9
20		10
21	Dante	1
22		2
23		3
24		4
25		5
26		6
27		7
28		8
29		9
30		10
31		11
32		12
33		13
34		14
35		15
36		16
	Not available	

## **Appendix 3 – AIR information**

Air is the name we give to the sonic signature of the classic transformer ISA Preamp. Our customers first coined this name as a simple description of the effect the ISA preamp added to their sound recordings. The three most significant attributes of the transformer design that create the “Air” effect are:

- Microphone interaction, created by the unique input impedance of the transformer coupling with the microphone output impedance.
- Clarity, created by the low distortion and high linearity of the transformer and preamp design.
- Frequency response tilt created by the transformer resonance resulting in an emphasis in the higher frequency content of the sound.

Engaging the AIR switches the impedance of the preamp, and enables the “transformer resonance effect”, giving your microphone recordings the air and clarity of an ISA transformer-based mic pre recording.

## PERFORMANCE AND SPECIFICATIONS

---

Microphone Inputs	
Gain Range	0 to 63 dB
Maximum Input Level	+19 dBu
Dynamic Range	118 dB 'A'-Weighted
Frequency Response	20 Hz – 35 kHz $\pm$ 0.2dB
THD + N	0.0009%
EIN	-129 dBu 'A'-Weighted (typical)

Line Inputs	
Maximum Input Level	+27 dBu <i>Channels 1 – 4</i> +26 dBu <i>Channels 5 – 8</i>
Dynamic Range	118 dB 'A'-Weighted
Frequency Response	20Hz – 35kHz $\pm$ 0.2dB
THD + N	0.0009% <i>Channels 1 – 4</i> 0.0007% <i>Channels 5 – 8</i>
Gain Range	0 to 63 dB <i>Channels 1 – 4 only</i>

Instrument Inputs	
Maximum Input Level	+15 dBu
Dynamic Range	117 dB
Frequency Response	20Hz – 35kHz $\pm$ 0.2dB
THD + N	0.0007%
Gain Range	0 to 63 dB

Monitor Outputs	
Maximum Output Level	+18 dBu <i>0 dBFS</i>
Dynamic Range	121 dB
Frequency Response	20Hz – 35kHz $\pm$ 0.25dB
THD + N	0.006%

Line Outputs	
Maximum Output Level	+18 dBu <i>0 dBFS</i>
Dynamic Range	121 dB
Frequency Response	20Hz – 35kHz $\pm$ 0.25dB
THD + N	0.0009%

<b>Headphone Outputs</b>	
Maximum Output Level	+16 dBu
Dynamic Range	115 dB
THD + N	0.01%

<b>Digital Performance</b>	
Supported Sample Rates	44.1 kHz, 48 kHz, 88.2 kHz, 96 kHz, 176.4 kHz, 192 kHz

<b>Dimensions</b>	
Height	44 mm / 1.73" [1RU]
Width	483 mm / 19"
Depth	340 mm / 13.4"

<b>Weight</b>	
Weight	4.97 kg / 10.96 lbs

<b>Power</b>	
PSU	Internal, 100-240V, 50/60Hz, consumption 35W

## **Focusrite Red 4Pre Warranty and Service**

All Focusrite products are built to the highest standards and should provide reliable performance for many years, subject to reasonable care, use, transportation and storage.

Very many of the products returned under warranty are found not to exhibit any fault at all. To avoid unnecessary inconvenience to you in terms of returning the product please contact Focusrite support.

In the event of a Manufacturing Defect becoming evident in a product within 12 months from the date of the original purchase Focusrite will ensure that the product is repaired or replaced free of charge.

A Manufacturing Defect is defined as a defect in the performance of the product as described and published by Focusrite. A Manufacturing Defect does not include damage caused by post-purchase transportation, storage or careless handling, nor damage caused by misuse.

Whilst this warranty is provided by Focusrite the warranty obligations are fulfilled by the distributor responsible for the country in which you purchased the product.

In the event that you need to contact the distributor regarding a warranty issue, or an out-of-warranty chargeable repair, please visit: [www.focusrite.com/distributors](http://www.focusrite.com/distributors)

The distributor will then advise you of the appropriate procedure for resolving the warranty issue. In every case it will be necessary to provide a copy of the original invoice or store receipt to the distributor. In the event that you are unable to provide proof of purchase directly then you should contact the reseller from whom you purchased the product and attempt to obtain proof of purchase from them.

Please do note that if you purchase a Focusrite product outside your country of residence or business you will not be entitled to ask your local Focusrite distributor to honour this limited warranty, although you may request an out-of-warranty chargeable repair.

This limited warranty is offered solely to products purchased from an Authorised Focusrite Reseller (defined as a reseller which has purchased the product directly from Focusrite Audio Engineering Limited in the UK, or one of its Authorised Distributors outside the UK). This Warranty is in addition to your statutory rights in the country of purchase.

## **Registering Your Product**

Please register your product at: [www.focusrite.com/register](http://www.focusrite.com/register)

## **Customer Support and Unit Servicing**

You can contact our Customer Support team free of charge:

Email: <https://support.focusrite.com/hc/en-gb/requests/new>

Phone (UK): +44 (0)1494 462246

Phone (USA): +1 (310) 322-5500

## **Troubleshooting**

If you are experiencing problems with your Red 4Pre, we recommend that in the first instance, you visit our Support Answerbase at: [www.focusrite.com/answerbase](http://www.focusrite.com/answerbase)